

**CI19 Series 1.50mm(.059") Wire to Board Connectors Housing & Terminal**

- ⊙ Mate with CI19 Header
- ⊙ Can be used with CI19 Crimp Clip Terminal
- ⊙ Insulator: High temperature plastic UL 94V-0, Color Nature

RoHS Compliant  

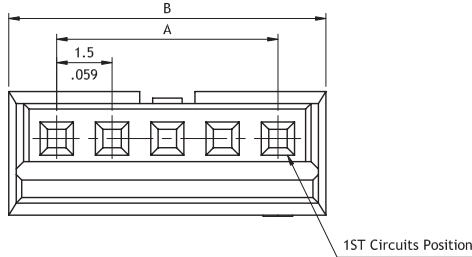
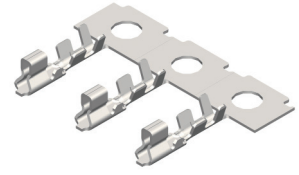
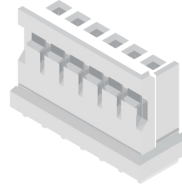

A = 1.5 \* No. of Spaces  
 B = A + 2.6  
 C = A + 2.2

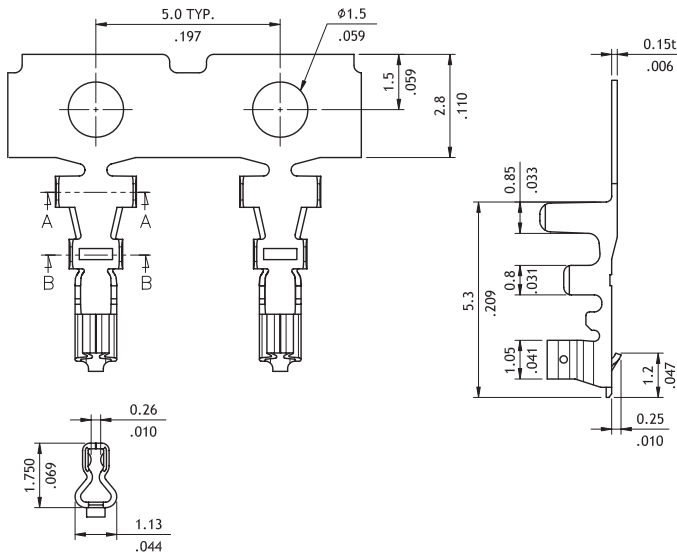
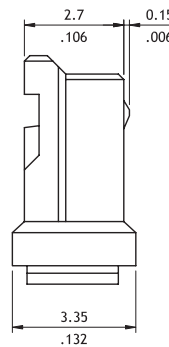
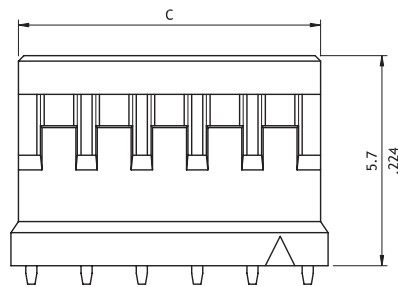

Wire Range	Insulation Diameter	Reel Qty
AWG #24-#30	1.1 (.043) MAX.	15,000 PCS.

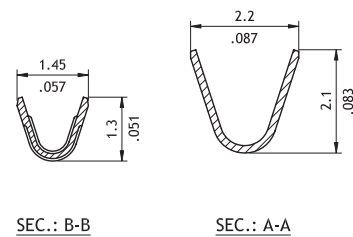

**Ordering Code**

① C ② I ③ 19 ④ 08 ⑤ S ⑥ L ⑦ 000 - ⑧ NH

- ① Series No.
- ② No. of Circuits: 02 to 15 (Available: 02 to 05, 08)
- ③ S = Housing
- ④ L = With Ramp
- ⑤ Other Options: 000 = Standard
- ⑥ Process: -NH = Halogen-Free

① C ② I ③ 19 ④ T ⑤ 01 ⑥ 1 ⑦ P ⑧ E ⑨ 0

- ① Series No.
- ② Type: T01 = AWG #24 ~ #30
- ③ Plating Code: 1 = Tin over Nickel
- ④ Material: P = Phosphor Bronze
- ⑤ Other Option: E0 = Standard