

CF31 Series 1.00mm(.039")H=1.95 SMT ZIF One-Touch FFC/FPC Connectors

- ⊙ 1.95mm above the board
- ⊙ FFC/FPC zero insertion force and high retention force
- ⊙ Insulator: High temperature plastic UL 94V-0, Color Nature
- ⊙ Cover: High temperature plastic UL 94V-0, Color Black
- ⊙ Designed easy for FFC/FPC installation and reliable operation
- ⊙ With metal fixed tabs to secure connector in place

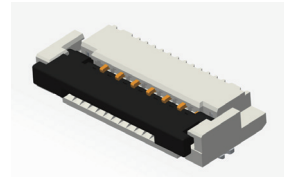

RoHS Compliant

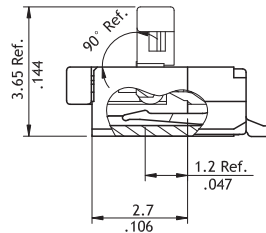
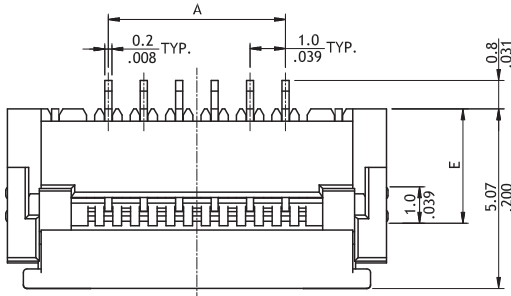

A = 1.0 x No. of Spaces
 B = A + 5.7
 C = A + 2.1

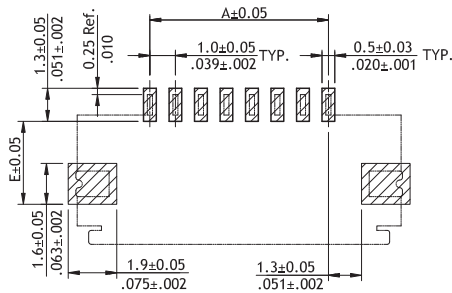
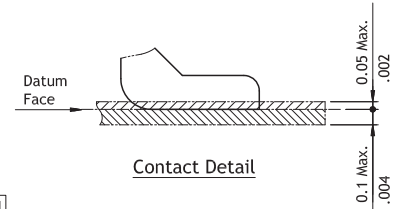
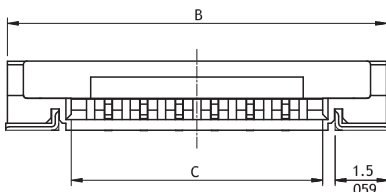

Recommended PCB Layout

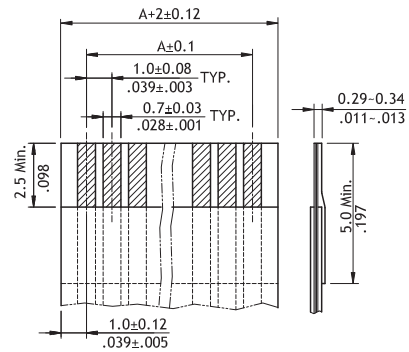

Accommodated FFC/FPC

Ordering Code

①	②	③	④	⑤	⑥	⑦	⑧	⑨
CF	31	30	1	D	0	R	0	- 10 - NH

- ① Series No.
- ② No. of Circuits: 04 to 30
Circuits not found above please consult manufacturer
- ③ Plating Code:
1 = Matte Tin over Nickel
2 = Gold flash over Nickel
- ④ Contact Style:
D = Downside Contact
- ⑤ Color: 0 = Nature
- ⑥ Packing:
R = Tape & Reel
- ⑦ Other Options:
0 = Without Mylar, E=3.20mm
2 = Without Mylar, E=2.85mm
- ⑧ Pitch: 10 = 1.00 mm
- ⑨ Process: -NH = For Lead Free IR process and Halogen-Free