

NOTE:

Material :

- △ * Base : High Temperature plastic UL 94V-0, Color Nature
- * Contact : Copper alloy
- * Fixed tab : Copper alloy with Tin or Gold Plated
- * For Lead-Free IR Reflow process

ORDERING CODE

CI18 ** M * H R 0 -NH
 ① ② ③ ④ ⑤ ⑥ ⑦ ⑧

- ① Series No.
- ② Contact: 02 to 22
- ③ M= SMT TYPE HEADER
- ④ Plating :
 1= Tin plated over Nickel
 2= Gold flash over 50u" Nickel
- ⑤ Type : H= Side entry
- ⑥ Packing option:
 R= Tape & Reel Packing
- ⑦ Other option:
 0= Standard
- ⑧ -NH= For Lead Free IR Processes and Halogen-Free

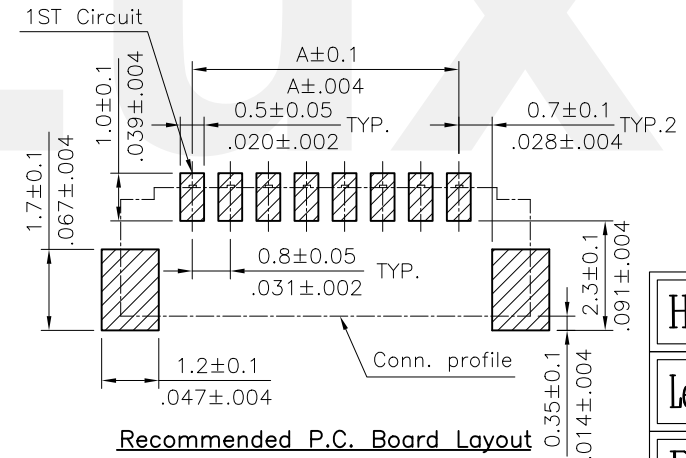
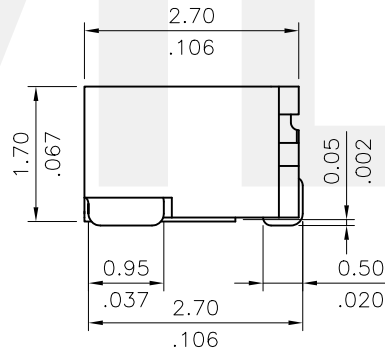
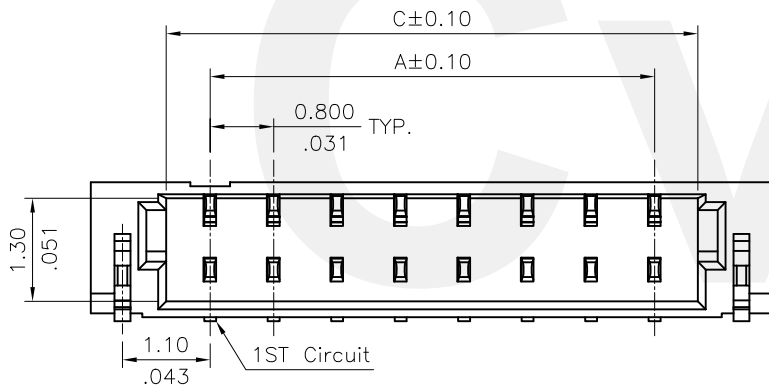
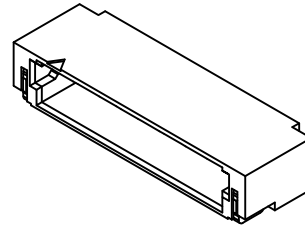
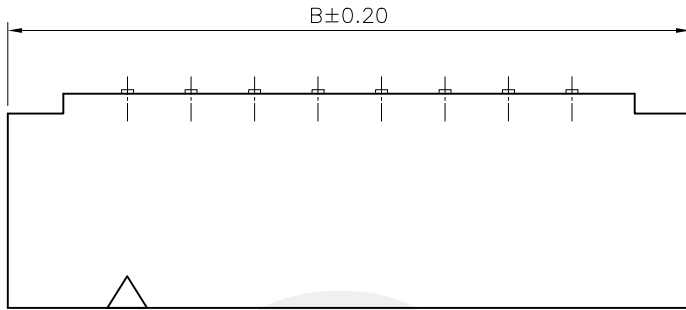

DIM. A = 0.80 x NO. OF SPACES
 DIM. B = DIM. A + 3.0
 DIM. C = DIM. A + 1.1
 * AVAILABLE IN 2 THROUGH 22

Halogen-Free

Lead Free Process

RoHS Compliant



△4	Sandy	6/6-16'	ECNT116118	2016.06.16 ISSUED		DATE	UNIT: mm / inch	TITLE: 0.8mm Pitch WTB SMT R/A TYPE	瀚荃股份有限公司 CviLux Corporation		
△3	Ellie	12/24-14	ECNT114252/ECRT114090		DRAWN BY: Sandy	6/6-16'	TOLERANCE UNLESS OTHERWISE SPECIFIED			DRAWING NO. CI1801SE PART NO. CI18**M*H*0-NH	
△2	Sun	9/17-14	ECRH114019/ECNT114194		ENGINEER: Sun	6/7-16'	.X ± 0.30/.012	.X' ± 1'			SCALE 10 / 1 SHEET 1 OF 2
△1	Enya	8/30-12'	ECR12043-2/ECN12209-0		CHECKED BY: Eisley	6/7-16'	.XX ± 0.20/.008	.X' ±			
SYM	NAME	DATE	REVISIONS		APPROVED BY: Eisley	6/7-16'	.XXX ± 0.10/.004	.XX' ±			

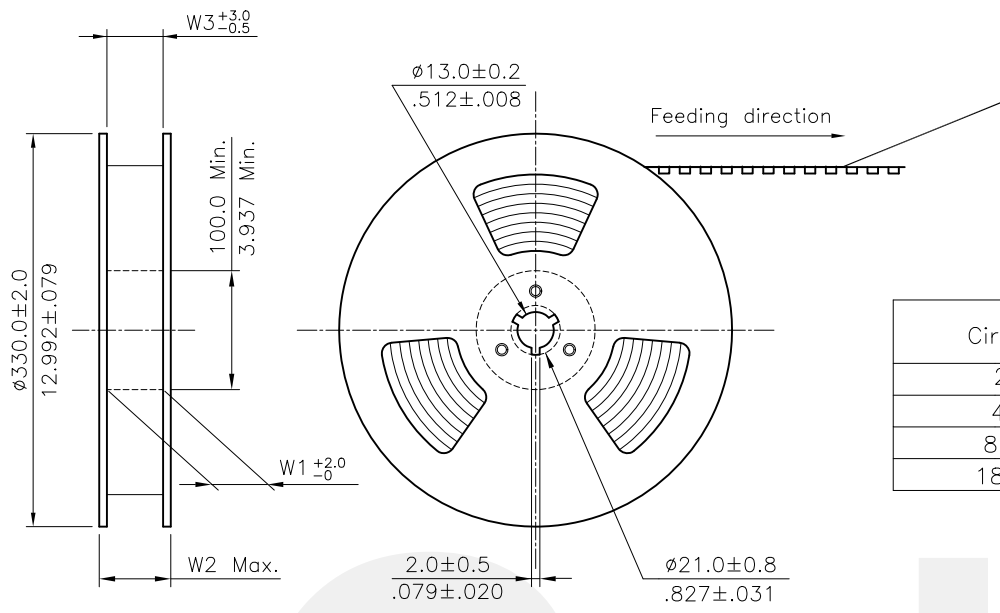

- NOTES:
1. 10 sprocket hole pitch cumulative tolerance ± 0.20
 2. Carrier camber is within 1 mm in 250 mm.
 3. Material : Clear, Polystyrene alloy
 4. All dimensions meet EIA-481-C requirements.
 5. Thickness : 0.30 ± 0.05 mm.
 6. Packing length per 22" Reel : 86.5 Meters.
 7. Component load per 13" Reel : 3500 pcs.

Circuits	Dimension					Packing (Reel/Caton)
	E	F	W1	W2	W3	
2~3	12.0(.470)	—	12.5(.491)	19.5(.768)	12.5(.491)	14
4~7	16.0(.630)	—	16.5(.650)	22.5(.885)	16.5(.650)	11
8~17	24.0(.945)	—	24.5(.965)	30.5(1.200)	24.5(.965)	9
18~22	32.0(1.260)	28.40(1.118)	32.5(1.280)	38.5(1.516)	32.5(1.280)	7

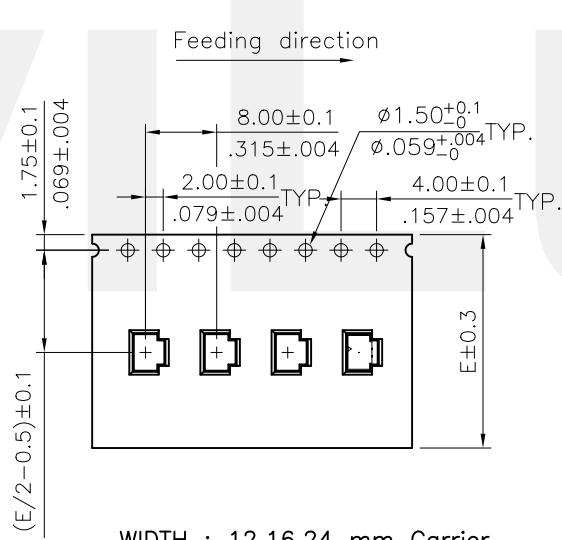
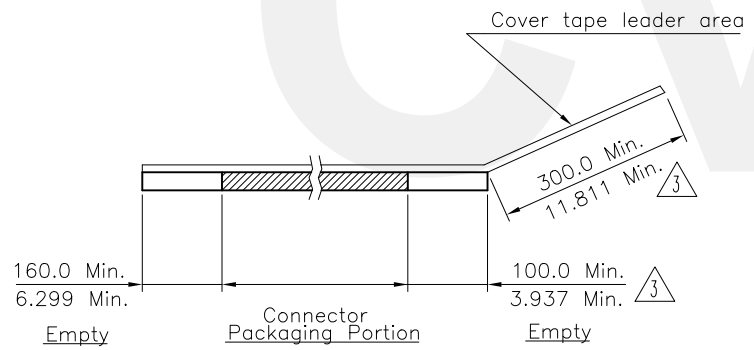

WIDTH : 12,16,24 mm Carrier

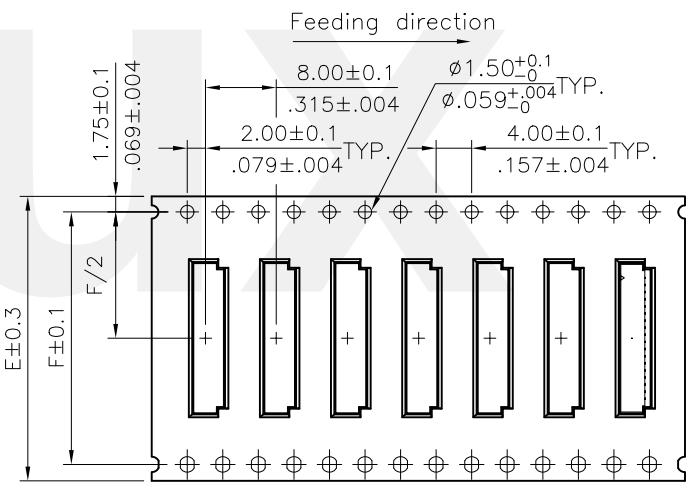

WIDTH : 32 mm Carrier

RoHS Compliant

4	Sandy	6/6-16'	ECNT116118		DATE	UNIT: mm / inch	TITLE: 0.8mm Pitch WTB SMT R/A TYPE	 瀚荃股份有限公司 CviLux Corporation		
3	Ellie	12/24-14'	ECNT114252/ECRT114090		DRAWN BY: Sandy	6/6-16'			TOLERANCE UNLESS OTHERWISE SPECIFIED	MATERIAL:
2	Sun	9/17-14'	ECRH114019/ECNT114194		ENGINEER: Sun	6/7-16'	.X ± X' ± ' "		FINISH:	
1	Enya	8/30-12'	ECR12043-2/ECN12209-0		CHECKED BY: Eisley	6/7-16'	.XX ± X' ± ' "			DRAWING NO. CI1801SE
SYM	NAME	DATE	REVISIONS		APPROVED BY: Eisley	6/7-16'	.XXX ± X' ± ' "		SCALE	SHEET 2 OF 2